



User's Manual

Compact Refrigerator

REF 121L-33 SS

Before using your product, please read this manual carefully and keep it for future reference.



TABLE OF CONTENTS

IMPORTANT SAFETY INSTRUCTIONS.....	1-2
PARTS AND FEATURES	3
INSTALLATION INSTRUCTIONS	
BEFORE USING YOUR REFRIGERATOR	4
INSTALLING YOUR REFRIGERATOR	4
ELECTRICAL CONNECTION.....	4
OPERATING YOUR REFRIGERATOR	
TEMPERATURE CONTROL.....	5
THE CHILLER COMPARTMENT.....	5
CHANGING THE REVERSIBLE DOOR	6
CARE AND MAINTENANCE	
CLEANING YOUR REFRIGERATOR.....	7
VACATION TIME.....	7
MOVING YOUR REFRIGERATOR.....	7
ENERGY SAVING TIPS.....	7
TROUBLESHOOTING GUIDE.....	8 - 9

Safety warnings

Definition of safety alert symbols



DANGER

DANGER indicates an imminently hazardous situation which, if not avoided, will result in death or serious injury.



WARNING

WARNING indicates a potentially hazardous situation which, if not avoided, could result in death or serious injury.



CAUTION

CAUTION indicates a potentially hazardous situation which, if not avoided, may result in minor or moderate injury.

SAVE THESE INSTRUCTIONS



DANGER

Risk of child entrapment.

Before you throw away your od refrigerator:

- Remove doors.
- Leave shelves in place so children may not easily climb inside.
- Have refrigerant removed by a qualified service technician.

GENERAL SAFETY RULES



WARNING: Read all of the instructions before using this appliance. When using this appliance, always exercise basic safety precautions, including the following;

NOTE: If the refrigerator has been placed in a horizontal or tilted position for any period of time wait 24 hours before plugging the unit in.

- 1) Use this appliance only for its intended purpose as described in this use and care guide.
- 2) This refrigerator must be properly installed in accordance with the installation instructions before it is used. See grounding instructions in the installation section.
- 3) Never unplug your refrigerator by pulling on the power cord. Always grasp the plug firmly and pull straight out from the outlet.
- 4) Repair or replace immediately, all electric service cords that have become frayed or otherwise damaged. Do not use a cord that shows cracks or abrasion damage along its length, the plug or the connector end.
- 5) Unplug your refrigerator before cleaning or before making any repairs.

Note: If for any reason this product requires service, please call customer service hotline at 1-866-646-4332

- 6) Do not use any electrical device or any sharp instrument in defrosting your refrigerator.
- 7) If your old refrigerator is not being used, we recommend that you remove the doors and leave the shelves in place. This will reduce the possibility of danger to children.



- 8) **WARNING:** After your refrigerator is in operation, do not touch the cold surfaces in the freezer compartment, particularly when hands are damp or wet. Skin may adhere to these extremely cold surfaces.

9) Do not refreeze foods that have been thawed completely. The United States Department of Agriculture in Home and Garden Bulletin No. 69 reads: " ...You may safely refreeze frozen foods that have thawed if they still contain ice crystals or if they are still cold-below 40 °F

" ...Thawed ground meats, poultry, or fish that have any off-odor or off-color should not be refrozen and should not be eaten. Thawed ice cream should be discarded. If the odor or color of any food is poor or questionable, discard it. The food may be dangerous to eat.

" ...Even partial thawing and re-freezing reduce the eating quality of foods, particularly fruits, vegetables, and prepared foods. The eating quality of red meats is affected less than that of many other foods. Use refrozen foods as soon as possible, to save as much of its eating quality as you can. "

10) This refrigerator should not be recessed or built-in in an enclosed cabinet. It is designed for freestanding installation only.

11) Do not operate your refrigerator in the presence of explosive fumes.

PARTS AND FEATURES

MODEL # WHS-121LW1/WHS-121LB1/WHS-121LSS1

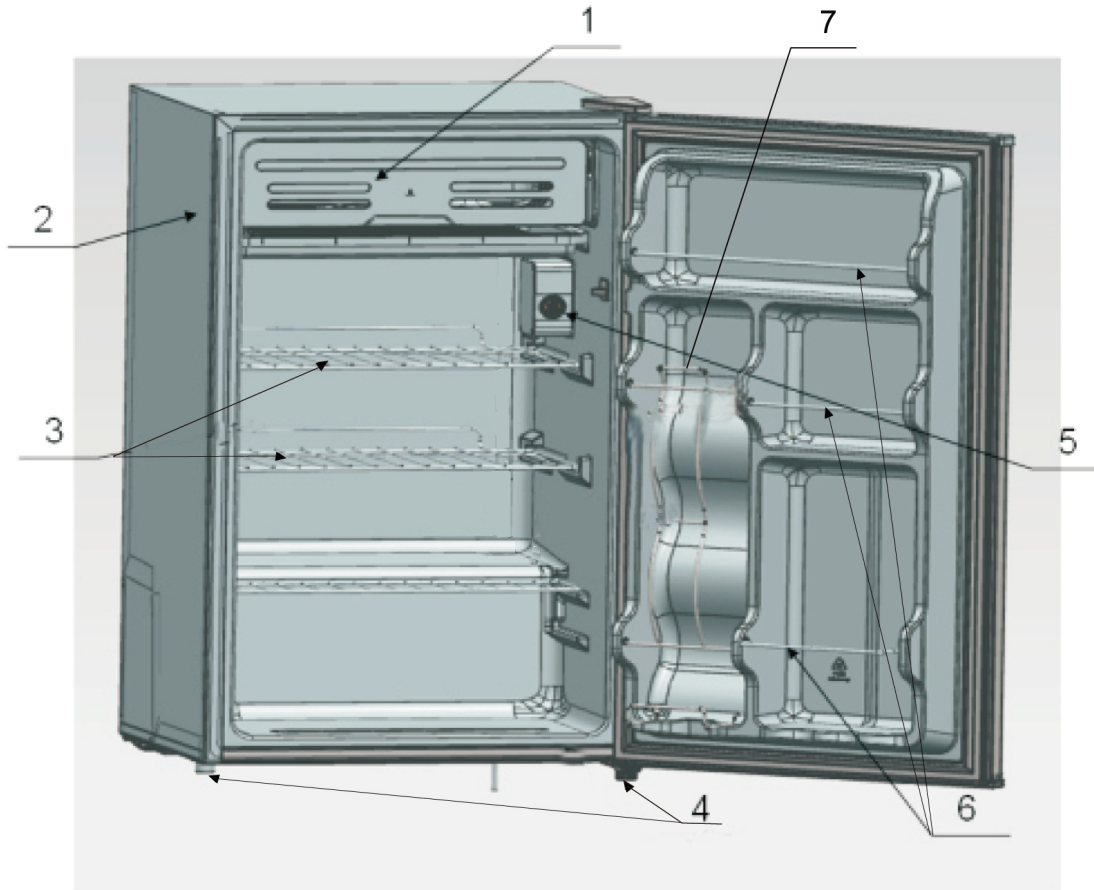

- | | | |
|------------------------|------------------------|--|
| 1. Chiller compartment | 2. Defrost drip tray | 3. Wire shelf (2) |
| 4. Leveling legs | 5. Temperature control | 6. Door storage shelf with wire retainer bar (3) |
| 7. Can storage | | |

⚠ WARNING : Never touch the interior of the freezer chamber or frozen foods in the compartment with wet hands as this could result in frost bite or injury.

INSTALLATION INSTRUCTIONS

Before Using Your Refrigerator

- Remove the exterior and interior packing.
- Before connecting the refrigerator to the power source, let it stand upright for approximately 4 hours. This will reduce the possibility of a malfunction in the cooling system from improper handling during transportation.
- Clean the interior surface with lukewarm water using a soft cloth. (Cleaning instruction on page 8)

Installing Your Refrigerator

- This appliance is designed to be free standing only, and should not be recessed or built-in.
- Place your refrigerator on a floor that is strong enough to support the refrigerator when it is fully loaded.
- Allow 5 inches of space between the back and sides of the refrigerator, which allows the proper air ventilation. Adjust the feet to keep the refrigerator level.
- Locate the refrigerator away from direct sunlight and sources of heat (stove, heater, radiator, etc.). Direct sunlight may affect the acrylic coating and heat sources may increase electrical consumption. Ambient temperature below 50°F (10°C) or above 85°F (29.4°C) will hinder the performance of this appliance. **This unit is not designed for use in a garage or any other outside installation.**
- Avoid locating the refrigerator in moist areas.
- Plug the refrigerator into dedicated, properly installed-grounded wall outlet. Do not under any circumstances cut or remove the third (ground) prong from the power cord. Any questions concerning power and/or grounding should be directed toward a certified electrician or an authorized service center. **This unit is not designed to be installed in an RV or used with an inverter.**
- After plugging the appliance into a wall outlet, turn the unit on and allow the unit to cool down for 2~3 hours before placing food in the refrigerator or freezer compartment.

Electrical Connection



Improper use of the grounded plug can result in the risk of electrical shock. If the power cord is damaged, have it replaced by an authorized service center.

This refrigerator should be properly grounded for your safety. The power cord of this refrigerator is equipped with a three-prong plug which mates with standard three prong wall outlets to minimize the possibility of electrical shock.

Do not, under any circumstances, cut or remove the third ground prong from the power cord supplied.

This refrigerator requires a standard 115 Volt A.C. ~/60Hz electrical outlet with three-prong ground.

This refrigerator is not designed to be used with an inverter.

The cord should be secured behind the refrigerator and not left exposed or dangling to prevent accidental injury.

Never unplug the refrigerator by pulling the power cord. Always grip the plug firmly and pull straight out from the receptacle.

Do not use an extension cord with this appliance. If the power cord is too short, have a qualified electrician or service technician install an outlet near the appliance. Use of an extension cord can negatively affect the performance of the unit.

OPERATING YOUR REFRIGERATOR

Temperature Control

- The temperature selector knob is located on the right hand side wall of the refrigerator interior
 - Setting “Off” : Unit Off
 - Setting “Min” : Less Cool Temperature
 - Setting “Med” : Normal Operation(adequate for most situations)
 - Setting “Max” : Coolest Temperature
- During high ambient temperatures e.g. on hot summer days. It may be necessary to set the thermostat to the Coolest setting(position “Max”).This may cause the compressor running continuously in order to maintain a low temperature in the cabinet.
- **For the first time you install your refrigerator, set the thermostat knob at “Med” .** Give your refrigerator time to cool down completely before adding food. It is the best to wait 24 hours before adding food. The thermostat knob controls the temperature. When the thermostat control knob is set to **OFF**, the refrigerator will not be running.

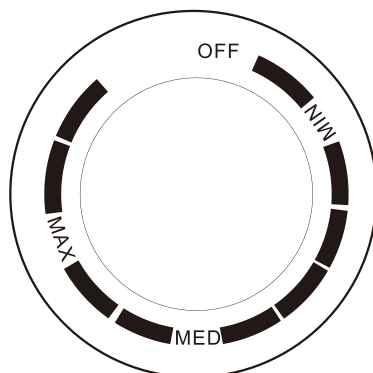

The Chiller Compartment

- This compartment is designed for ice making and short-term storage of some commercially frozen foods.
- The chiller compartment may not reach temperatures low enough to freeze frozen foods. It works well when the food is already frozen prior to storage.
- Place frozen food into the freezer as quickly as possible after purchase. If there are instructions on the packet, carefully follow these instructions regarding storage times.

CHANGING THE REVERSIBLE DOOR

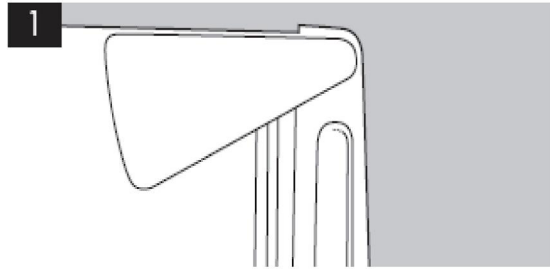

Remove the plastic covering from the bottom door hinge.

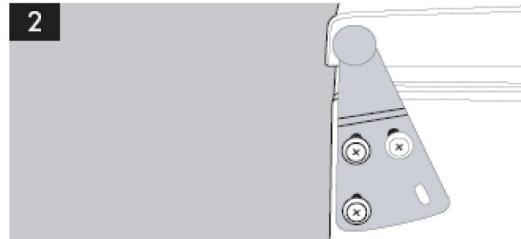

Unscrew the three screws from the bottom bracket. Remove the foot from opposite side.

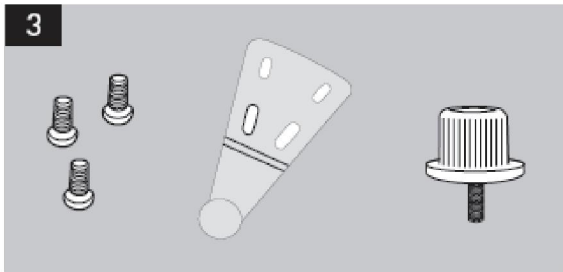

Place to one side.

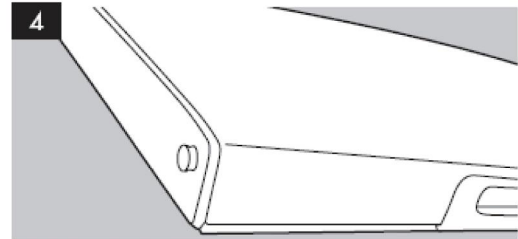

Slide the Table Top Fridge door down about 15cm [6"] and off the Top hinge pin and lift away from the Table Top Fridge.

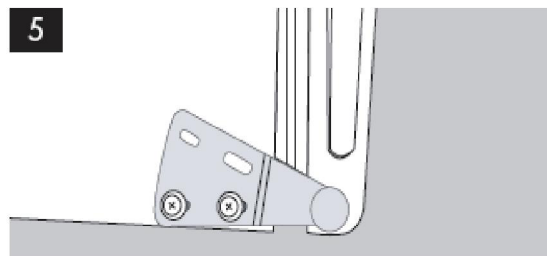

Remove the two screws from top bracket and replace on the other side. You will need to first remove the plastic caps from the other side.

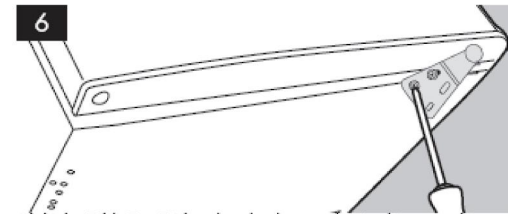

Slide the Table Top Fridge door back on to the Top hinge, making sure it's the right way up. Screw the bottom hinge into place on the new side. Replace the other foot on the other side. Replace the plastic covering by clicking back into position on the door hinge.



Check that the door is aligned horizontally and vertically and that the seals are closed on all sides before finally tightening the bottom hinge.

Re-adjust the levelling feet.

CARE AND MAINTENANCE

Cleaning Your Refrigerator

- Upon installation of your new appliance, it is recommended that it be cleaned thoroughly.
- Turn off the refrigerator first and then unplug the unit from the wall outlet.
- Remove all food content.
- Wash the inside with a damp warm cloth soaked in lukewarm water and baking soda solution. The solution should be about 2 tablespoons of baking soda to a quart of water.
- Be sure to keep the door gasket (seal) clean to keep the unit running efficiently.
- The outside of the refrigerator should be cleaned with mild detergent and warm water.
- Dry the interior and exterior with a soft cloth.

Vacation Time

- Turn off the refrigerator first and then unplug the unit from the wall outlet.
- Remove all the food.
- Clean the refrigerator.
- Leave the lid open slightly to avoid possible formation of condensation, mold, or odors.
- Use extreme caution in the case of children. The unit should not be accessible to child's play.
- **Short vacations:** Leave the refrigerator operating during vacations of less than three weeks.
- **Long vacations:** If the appliance will not be used for several months, remove all food and unplug the power cord. Clean and dry the interior thoroughly. To prevent odor and mold growth, leave the door open slightly: blocking it open if necessary or have the door removed.

Moving Your Refrigerator

- Turn off the refrigerator first and then unplug the unit from the wall outlet.
- Remove all the food.
- Securely tape down all loose items inside your refrigerator.
- Tape the doors shut.
- Be sure the refrigerator stays in the upright position during transportation.

Energy Saving Tips

- The refrigerator should be located in the coolest area of the room, away from heat producing appliances or heating ducts, and out of the direct sunlight.
- Let hot foods cool to room temperature before placing in the refrigerator. Overloading the refrigerator forces the compressor to run longer. Foods that freeze too slowly may lose quality, or spoil.
- Be sure to wrap foods properly, and wipe containers dry before placing them in the refrigerator. This cuts down on frost build-up inside the refrigerator.
- Organize and label food to reduce door openings and extended searches. Remove as many items as needed at one time, and close the door as soon as possible.

TROUBLESHOOTING GUIDE

You can solve many common refrigerator problems easily, saving you the cost of a possible service call. Try the suggestions below to see if you can solve the problem before calling for service.

PROBLEM	POSSIBLE CAUSE
Refrigerator does not operate.	Not plugged in. The circuit breaker tripped or a blown fuse.
Compressor turns on and off frequently.	The room temperature is hotter than normal. A large amount of food has been added to the refrigerator. The door is opened too often. The door is not closed completely. The temperature control is not set correctly. The door gasket does not seal properly. The refrigerator does not have the correct clearances. The refrigerator has recently been disconnected for a period of time. 4 hours are required for the refrigerator to cool down completely.
Temperature inside the refrigerator is too warm.	Temperature control is set too warm. Turn the control to a cooler setting and allow several hours for the temperature to stabilize. Door is kept open too long or is opened too frequently. Warm air enters the refrigerator every time the door is opened. Open the door less often. The door is not closed completely. The door gasket does not seal properly. A large amount of warm or hot food might have been stored recently. Wait until the refrigerator has had a chance to reach its selected temperature. The refrigerator has recently been disconnected for a period of time. 4 hours are required for the refrigerator to cool down completely.
Temperature inside the refrigerator is too cold.	Temperature control is set too cold. Turn the control to a warmer setting and allow several hours for the temperature to stabilize.
Temperature of external refrigerator surface is warm.	The exterior refrigerator walls can be as much as 30°F warmer than room temperature. This is normal while the compressor works to transfer heat from inside the refrigerator cabinet.
Popping or cracking sound when compressor comes on.	Metal parts undergo expansion and contraction, as in hot water pipes. This is normal. Sound will level off or disappear as refrigerator continues to run.
Bubbling or gurgling sound, like water boiling.	Refrigerant (used to cool refrigerator) is circulating throughout the system. This is normal.
Vibrations.	Check to assure that the refrigerator is on a level surface. Floor is uneven or weak. Refrigerator rocks on the floor when it is moved slightly. Be sure floor

	<p>can adequately support refrigerator. Level the refrigerator by putting wood or metal shims under part of the refrigerator.</p> <p>The refrigerator is touching the wall. Re-level the refrigerator and move it from the wall.</p> <p>See "Installation Instructions".</p>
Moisture forms on inside refrigerator walls.	<p>Weather is hot and humid, which increases internal rate of frost build-up. This is normal.</p> <p>Door is slightly open.</p> <p>Door is kept open too long, or is opened too frequently. Open the door less often.</p> <p>The door is not sealed properly.</p>
Moisture forms on outside of refrigerator.	<p>Door is slightly open, causing cold air from inside the refrigerator to meet warm moist air from outside.</p>
The door will not close properly.	<p>The refrigerator is not on a level surface.</p> <p>The gasket is dirty.</p>

For more information, please visit our website
www.midea.com

